



The Syrex IS-SB combined unit is CE marked for compliance with the European Explosive Atmospheres Directive 94/9/EC and the European EMC Directive 89/336/EEC

1) Introduction

The Syrex IS-SB is a second generation ATEX certified intrinsically safe combined sounder/beacon unit which produces both a loud audio warning and a visual warning and can be installed in a hazardous area. The sounder section has forty-nine first stage alarm sounds that can be selected by internal switches and each one can be externally changed to a second or third stage alarm sound. The beacon section can be set internally for a flash rate of either 1Hz or 2Hz. The combined unit sounder and beacon can be operated simultaneously from one barrier or from separate barriers if independent operation is required. The IS-mC1 Combined Unit can be used in all gas groups IIA IIB and IIC.

2) Description

Fig 1 shows a simplified block diagram of an IS-SB sounder section. The device operates immediately power is applied to the sounder + and – terminals which are duplicated to allow a second sounder to be connected in parallel, or for an end of line monitoring resistor to be installed. The output tone is defined by the positions of the six internal switches and this tone can be changed to a second or third stage alarm tone by connecting terminals S2 or S3 to 0V. The tone generator is crystal controlled to ensure that when two sounders connected to the same power supply are started at the same time the output tones remain synchronised.

3) Supply Voltage

The Syrex IS-SB unit has been designed to operate in a hazardous area from a 24V dc supply via a 28V 93mA resistive ATEX certified Zener barrier or galvanic isolator. The unit may be tested or used in safe areas without a Zener barrier or galvanic isolator, but at supply voltages above 16V the internal current limit will function and therefore it is recommended that they are not operated continuously with a direct supply greater than 16V.

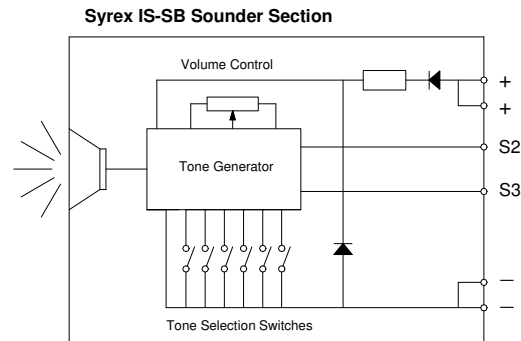

Fig 1 Simplified block diagram

4) Intrinsic Safety Certification

4.1 ATEX certificate

The Syrex IS-SB combined unit complies with the following standards:-

EN50014 : 1997 + A1 and A2,
EN50020 : 2002
EN50284 : 1999



II 1G EEx ia IIC T4 (-40°C ≤ Ta ≤ +60°C)

The EC-Type Examination Certificate SIRA 05ATEX2269X has been issued by the Notified Body Sira. This confirms compliance with the European ATEX Directive 94/9/EC for Group II, Category 1G equipment. The sounder carries the Community Mark and subject to local codes of practice, may be installed in any of the EEA member countries. This instruction sheet describes installations which conform to BS EN60079:Part14:2003 Electrical Installation in Hazardous Areas. When designing systems for installation outside the UK, the local Code of Practice should be consulted.

- 1) The certification marking is as follows:

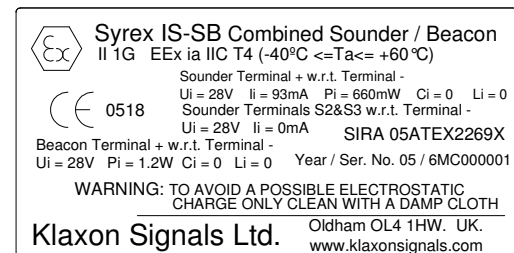

- 2) The equipment may be used in zones 0, 1 and 2 with flammable gases and vapours with apparatus groups IIA, IIB & IIC and with temperature classes T1, T2, T3 and T4.
- 3) The equipment is only certified for use in ambient temperatures in the range -40°C to +60°C and should not be used outside this range.

- 4) The certificate number has an 'X' suffix, which indicates that the certificate contains one of more special conditions for safe use. Those installing or inspecting the equipment should refer to this section of the certificate.
- 5) The equipment has not been assessed as a safety-related device (as referred to by Directive 94/9/EC Annex II, clause 1.5).
- 6) Installation of this equipment shall be carried out by suitably-trained personnel in accordance with the applicable code of practice.
- 7) Repair of this equipment shall only be carried out by the manufacturer or in accordance with the applicable code of practice.
- 8) The certification of this equipment relies on the following materials used in its construction:

Enclosure: ABS Plastic
 Lens: Polycarbonate

If the equipment is likely to come into contact with aggressive substances, then it is the responsibility of the user to take suitable precautions that prevent it from being adversely affected, thus ensuring that the type of protection is not compromised.

"Aggressive substances" - e.g. acidic liquids or gases that may attack metals, or solvents that may affect polymeric materials.

"Suitable precautions" - e.g. regular checks as part of routine inspections or establishing from the material's data sheet that it is resistant to specific chemicals.

SPECIAL CONDITIONS FOR SAFE USE (as stated in the EC Type Examination Certificate SIRA 05ATEX2269X)

Conditions for Syrex IS-SB Combined Sounder / Beacon

The equipment has an ingress protection rating of IP65. However, if it has been supplied without cable entry devices, then the user shall ensure that the devices that are fitted will provide an ingress protection that is appropriate to the environment in which it is installed i.e. IP20 or better. If only one of the two cable entries are used, then the unused entry 'knockout' shall be left intact or fitted with a blanking device that ensures ingress protection appropriate to the environment in which it is installed i.e. IP20 or better.

The equipment shall not be directly installed in any process where its enclosure might be electro-statically charged by the rapid flow of a non-conductive media.

The equipment shall only be supplied via Sounder Terminals + w.r.t. Sounder Terminals - from a barrier having a maximum open circuit voltage U_0 that is $\leq 28V$ and a maximum short circuit current I_0 that is $\leq 93mA$, where I_0 is resistively limited. The barrier shall be ATEX certified by a notified body.

If not already fitted optional internal wiring connections between Sounder Terminals + / - and Beacon Terminals + / - may be fitted by the user. The wiring used for such connections shall have a minimum radial thickness of insulation of 0.5mm.

4.2 Zones, Gas Groups and Temperature Classification

The Syrex IS-SB unit has been certified EEx ia IIC T4. When connected to an approved system it may be installed in:

- Zone 0 explosive gas air mixture continuously present.
- Zone 1 explosive gas air mixture likely to occur in normal operation.
- Zone 2 explosive gas air mixture not likely to occur, and if it does, it will only exist for a short time.

Be used with gases in groups:

- Group A propane
- Group B ethylene
- Group C hydrogen

Having a temperature classification of:

- T1 450°C
- T2 300°C
- T3 200°C
- T4 135°C

4.3 Sounder + and - Terminals

Power is supplied to the sounder section via the sounder input terminals + and - on the sounder PCB (see Fig 2) and the terminals have the following input safety parameters:

$U_i = 28V$
 $I_i = 93mA$
 $P_i = 660mW$

$C_i = 0 \quad L_i = 0$

The Syrex IS-SB combined sounder section may be powered from an ATEX certified Zener barrier or galvanic isolator which have output parameters equal to or less than 28V, 93mA and 660mW, where I_0 is resistively limited. The cable parameters stated on the selected Zener barrier or galvanic isolator certificate must be observed.

4.4 Sounder S2 and S3 Terminals

When terminals S2 or S3 are connected to 0V (- terminal) the sounder output tone changes to the second or third stage alarm respectively. The input safety parameters for these terminals are:

$U_i = 28V$
 $I_i = 0mA$

Because the permitted input current is zero, these terminals may only be connected to a diode return barrier, an intrinsically safe relay or a galvanic isolator, all of which must have been certified by an EC Notified Body. Only diode return barriers with a voltage drop of less than 0.9V may be used. Alternatively, these terminals may be connected directly to a mechanically activated switch within the hazardous area.

4.5 Beacon + and - Terminals

Power is supplied to the beacon section via the beacon input terminals + and - on the beacon PCB (see Fig 2) and the terminals have the following input safety parameters:

$U_i = 28V$
 $P_i = 1.2W$

$C_i = 0 \quad L_i = 0$

The Syrex IS-SB combined beacon section may be powered from any 28V 1.2W ATEX certified Zener barrier or galvanic

isolator. The cable parameters stated on the selected Zener barrier or galvanic isolator certificate must be observed.

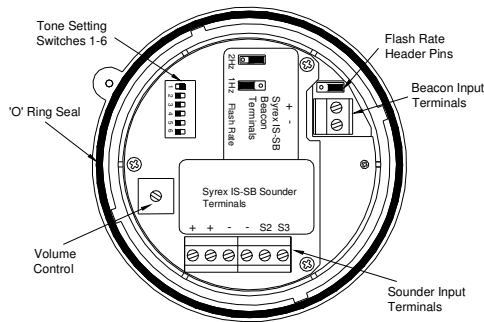

Fig 2 Location of field terminals and controls.

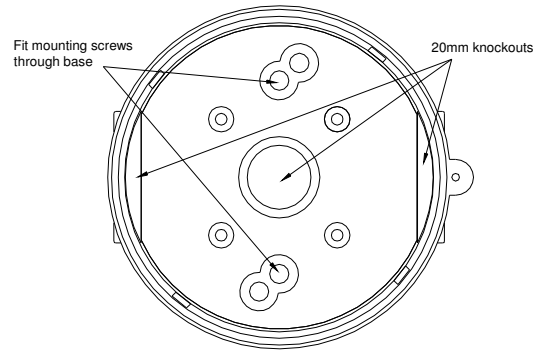

Fig 3 Mounting Combined Unit Base.

5) Installation

The Syrex IS-SB combined unit should only be installed by trained competent personnel.

5.1 Mounting

The Syrex IS-SB combined unit may be secured to any flat surface by inserting two mounting screws through the back of the round base (see figure 3). The enclosure provides IP65 protection and is suitable for installation in exterior locations provided that the area around the two mounting screws through the back of the base moulding has been sealed and that suitable cable glands with the required IP rating have been used.

5.2 Installation procedure

- Unscrew the combined unit security screw and remove the sounder/beacon section from the base by turning it anti-clockwise. Ensure that the 'O' ring seal remains in place.
- Remove the required 20mm knockout section(s) depending on system wiring and mount the base to a flat surface by inserting two screws through the back of the base.
- Fit the required number of 20mm cable glands or conduit entries into the base and connect the field wiring to the appropriate sounder terminals as shown in section 6 and fig 2 of this manual. The power supply terminals + and - are duplicated so that sounders may be connected in parallel, or an end of line monitoring resistor may be fitted.
- Select the required sounder output tone by positioning the six switches as shown in Table 1 and Fig 2.
- Apply power to the sounder and adjust the internal volume control to provide the required sound level.
- Check that the 'O' ring seal is correctly located on the sounder/beacon section (see Fig. 2) and insert the sounder/beacon section into the base. Push it fully home and turn it clockwise to align the mouldings before tightening the security screw.

6) Electrical System Design For Installation In Hazardous Areas Using Zener Barriers

6.1 Sounder single stage alarm

If the control switch is in the positive supply, or the power supply is being turned on and off, only a single channel Zener barrier is required as shown in Fig 4. This circuit may also be used if the sounder is being controlled by a mechanically activated switch on the hazardous area side of the barrier.

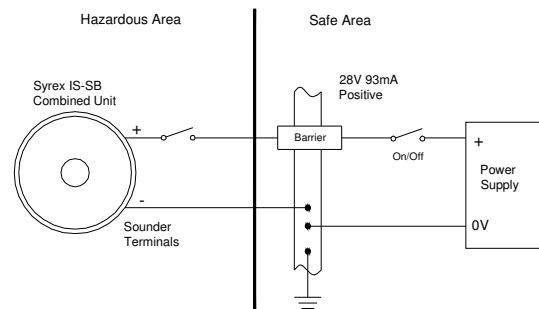

Fig 4 Sounder single stage alarm using single channel barrier.

If the control switch must be in the negative supply, the circuit shown in Fig 5 may be used. Any diode return barrier certified EEx ia by a EC Notified Body may be used, providing its voltage drop is less than 0.9V.

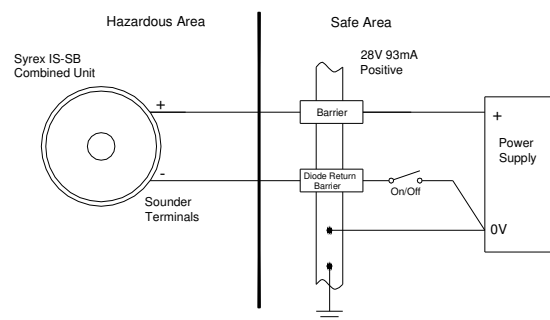

Fig 5 Sounder single stage alarm using two channel barrier.

Syrex IS

Tone Table

TONE	TONE TYPE	TONE DESCRIPTION/ APPLICATION	2 ND STAGE TONE	3 RD STAGE TONE	DIP SWITCH 1 2 3 4 5
1		340Hz	2	5	0-0-0-0-0-0
2		800Hz/970Hz @ 2Hz (BS5839-1:2002)	17	5	1-0-0-0-0-0
3		500 - 1200Hz, 3.5s/ 0.5s OFF (Netherlands - NEN 2575:2000)	2	5	0-1-0-0-0-0
4		800 - 970Hz @ 1Hz (BS5839-1:2002)	6	5	1-1-0-0-0-0
5		2400Hz	3	20	0-0-1-0-0-0
6		2500Hz - 2850Hz @ 7Hz.	7	5	1-0-1-0-0-0
7		2500Hz - 2850Hz @ 1Hz.	10	5	0-1-1-0-0-0
8		500Hz - 1200Hz - 500Hz @ 0.33Hz.	2	5	1-1-1-0-0-0
9		1200Hz - 500Hz @ 1Hz (DIN 33 404)	15	2	0-0-0-1-0-0
10		2500Hz/2850Hz @ 2Hz	7	5	1-0-0-1-0-0
11		970Hz 1s OFF/1s ON (Apollo Fire Systems Alert Tone, BS5839-1:2002)	2	5	0-1-0-1-0-0
12		800/1000Hz @ 0.875Hz	4	5	1-1-0-1-0-0
13		2400Hz 1s ON/1s OFF	15	5	0-0-1-1-0-0
14		800Hz 0.25s ON/1s OFF	4	5	1-0-1-1-0-0
15		750Hz	2	5	0-1-1-1-0-0
16		660Hz 0.15s ON/0.15s OFF	18	5	1-1-1-1-0-0
17		554Hz, 0.1s/ 440Hz, 0.4s (France - AFNOR NF S 32 001)	2	27	0-0-0-0-1-0
18		660Hz 1.8s ON/1.8s OFF	2	5	1-0-0-0-1-0
19		1400Hz - 1600Hz 1s/1600Hz - 1400Hz 0.5s	2	5	0-1-0-0-1-0
20		660Hz	2	5	1-1-0-0-1-0
21		550Hz/440Hz @ 0.5Hz	2	5	0-0-1-0-1-0
22		544Hz @ 0.875Hz	2	5	1-0-1-0-1-0
23		800Hz 0.25s ON/0.25s OFF	6	5	0-1-1-0-1-0
24		800 - 970Hz @ 50Hz (Buzzer)	29	5	1-1-1-0-1-0
25		2500 - 2850Hz @ 50Hz (Buzzer)	29	5	0-0-0-1-1-0
26		Simulated Bell	2	15	1-0-0-1-1-0
27		554Hz	26	5	0-1-0-1-1-0
28		400Hz	2	5	1-1-0-1-1-0
29		800 - 970Hz @ 7Hz	7	5	0-0-1-1-1-0
30		300Hz	2	5	1-0-1-1-1-0
31		660 - 1200Hz @ 1Hz	26	5	0-1-1-1-1-0
32		Two Tone Chime	26	15	1-1-1-1-1-0
33		745Hz 1s ON/1s OFF	2	5	0-0-0-0-0-1
34		1000Hz/2000Hz @ 1Hz	38	45	1-0-0-0-0-1
35		420Hz 0.625s ON/0.625s OFF (Australia AS2220 Alert tone)	36	5	0-1-0-0-0-1
36		500 - 1200Hz, 3.75s/ 0.25s OFF (Australia AS2220 Evacuation tone)	35	5	1-1-0-0-0-1
37		970Hz (BS5839-1:2002)	9	45	0-0-1-0-0-1
38		2000Hz	34	45	1-0-1-0-0-1
39		800Hz 0.25s ON/1s OFF	23	17	0-1-1-0-0-1
40		554Hz, 0.1s/ 440Hz, 0.4s (France - AFNOR NF S 32 001)	31	27	1-1-1-0-0-1
41		Motor Siren - Slow Rise to 1200Hz	2	5	0-0-0-1-0-1
42		Motor Siren - Slow Rise to 800Hz	2	5	1-0-0-1-0-1
43		1200Hz	2	5	0-1-0-1-0-1
44		Motor Siren - Slow Rise to 2400Hz	2	5	1-1-0-1-0-1
45		970Hz 1s OFF/1s ON (Apollo Fire Systems Alert Tone, BS5839-1:2002)	38	34	0-0-1-1-0-1
46		1200Hz - 500Hz @ 1Hz (PFEER PTAP)	47	37	1-0-1-1-0-1
47		1000Hz 1s ON/1s OFF	46	37	0-1-1-1-0-1
48		420Hz 0.625s ON/0.625s OFF (Australia AS2220 Alert tone)	49	5	1-1-1-1-0-1
49		500 - 1200Hz, 3.75s/ 0.25s OFF (Australia AS2220 Evacuation tone)	26	37	0-0-0-0-1-1

6.2 Sounder multi-stage alarm

Connecting terminal S2 to 0V activates the second stage alarm, and similarly terminal S3 for the third stage alarm. Fig 6 shows how the diode return barriers may be used. If only two stages of alarm are required the third stage barrier should be omitted, the 28V 93mA barrier and the single diode return channel may then be contained in one package.

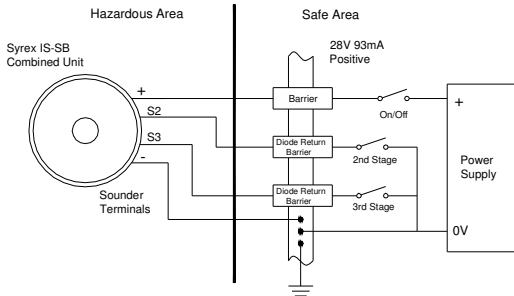

Fig 6 Sounder multi stage alarm using Zener barriers.

6.3 Beacon operation

The beacon can be operated from the same Zener barrier being used to power the sounder (see Fig 7) or from a separate barrier if the sounder and beacon need to operate independently (see Fig 8). A Diode return barrier can be used if the sounder second and third stage tones are required.

NOTE: If the beacon is operated from the same barrier as the sounder then the sounder and beacon boards must be connected together as shown in Fig 7 using connecting wires that have a minimum radial thickness of insulation of 0.5mm. Also the barrier used must meet the requirements for the sounder section (see section 4.3).

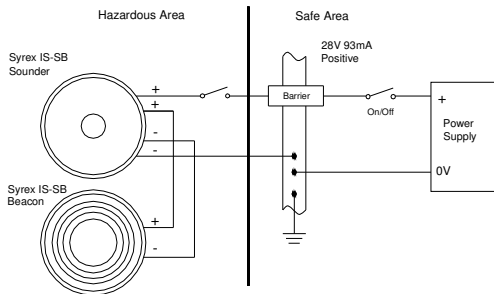

Fig 7 Combined Unit wired for simultaneous operation using one Zener barrier.

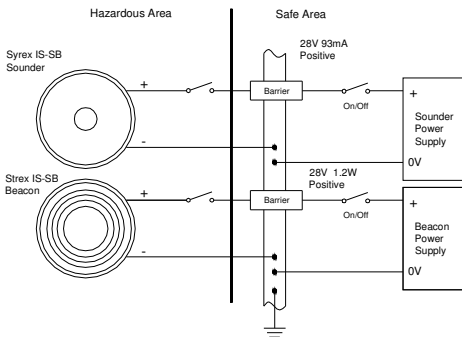

Fig 8 Combined Unit wired for independent operation using separate Zener barriers.

7) Electrical System Design For Installation In Hazardous Areas Using Galvanic Isolators

Galvanic isolators do not require a high integrity earth connection. For small systems where a high integrity earth is not already available, the use of galvanic isolators often reduces the overall installation cost and simplifies design.

7.1 Sounder single stage alarm

The Syrex IS-SB combined unit may be powered by any galvanic isolator having output parameters within the limits specified in section 4.3, which has been certified EEx ia by an EC Notified Body. The combined unit may be controlled by turning the galvanic isolator on and off, or by a mechanically activated switch on the hazardous area side of the isolator.

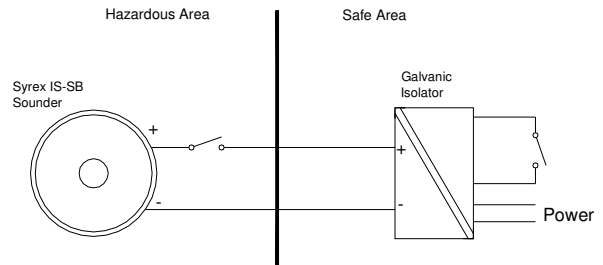

Fig 9 Sounder single stage alarm using galvanic isolator.

6.2 Beacon operation

The beacon can be operated from the same isolator being used to power the sounder (see Fig 10) or from a separate isolator if the sounder and beacon need to operate independently (see Fig 11).

NOTE: If the beacon is operated from the same isolator as the sounder then the sounder and beacon boards must be connected together as shown in Fig 10 using connecting wires that have a minimum radial thickness of insulation of 0.5mm. Also the isolator used must meet the requirements for the sounder section (see section 4.3).

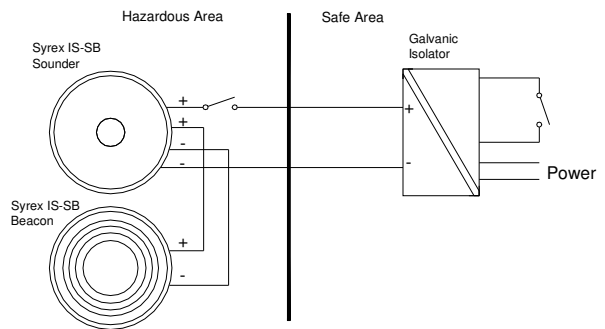

Fig 10 Combined Unit wired for simultaneous operation using one isolator.

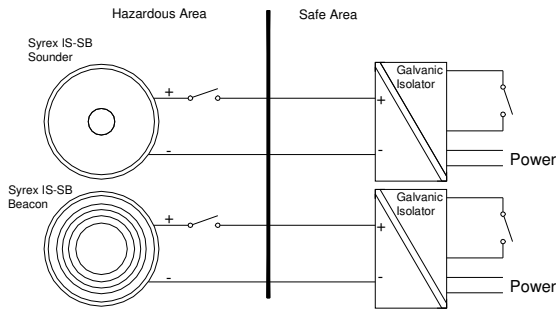

Fig 11 Combined Unit wired for independent operation using separate isolators

8) Cable Parameters

The maximum permitted cable parameters are as specified on the certificate of the Zener barrier or galvanic isolator that has been selected for the installation. Normally the limits are not restrictive, but care should be taken not to exceed a capacitive limit of 83nF for installations when very long cables are used.

9) Servicing

No attempt should be made to repair a faulty Syrex IS-SB combined sounder / beacon. Suspect units should be returned to Klaxon Signals Ltd. for repair.

10) Guarantee

Sounders that fail within the guarantee period should be returned to Klaxon Signals Ltd. It is helpful if a brief description of the fault symptoms is provided.